



**COZY**MATIC

**Lomas Leather Lounge Chair  
with Ottoman**

Assembly Instructions











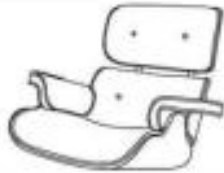





**COZYMATIC**





## Parts List

Label	Picture	Description	QTY
1		Chair	1
2		Five Star Metal base	1
A		Chair Back Rest	1
B		Chair Seat	1
C1	 Left	Chair Arm Rest	1
C2	 Right	Chair Arm Rest	1
D1	 Left	Steel Bracket	1
D2	 Right	Steel Bracket	1
E		Chair Base	1
F		Metal Leg	1
G		Hexagon Sliver Screws-M8*15mm	10
L5		Allen Key	1
H		Phillips head screw-Ø6*15mm	4
I		Phillips head screw-Ø6*25mm+Chair Washer	4
J		Hexagon Slicer Screws-M8*15mm+Chair Washer	1



## step 1



Assemble the Chair Base ( E ) and Metal Leg( F ) as shown,then fix insert Iron bolt+Chair Washer(J)+ (G) into chair leg base,in sequence. That part②

## step 2

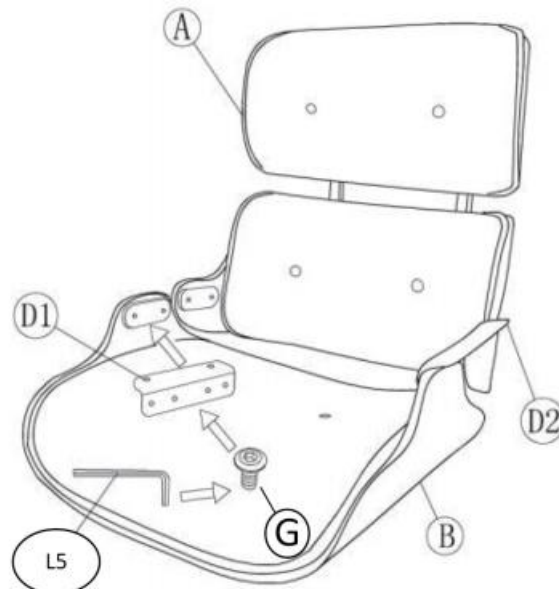

Attach chair backrest (A)and Chair Seat(B) by using the Steel Brackets ( D1/D2 ) ,using 4 silver screws in sequence.



### step 3

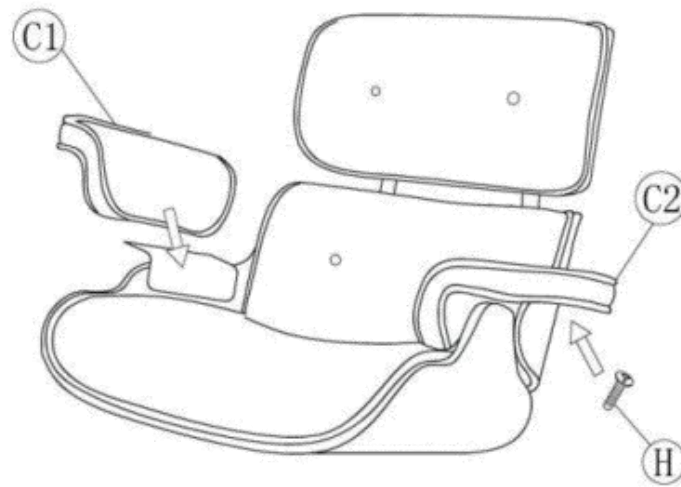

Attach armrest (C1&C2) using 4 screws (H) to the Steel Bracket (D1&D2) .Keeping the leather stitching towards back.Thats part①.

### step 4

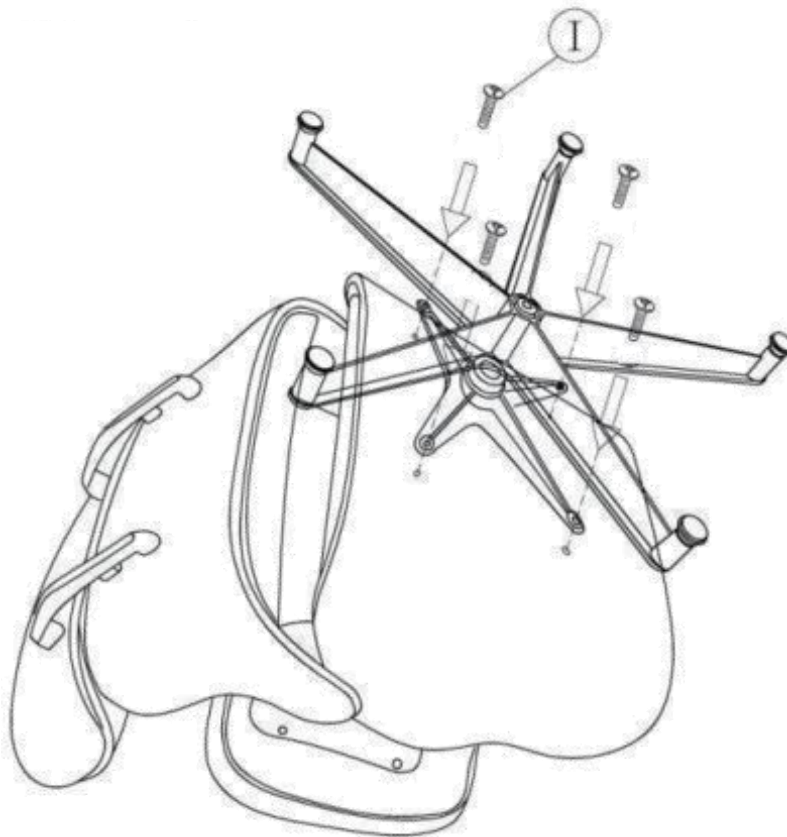

Assemble part ① and ② as shown.









**COZYMATIC**



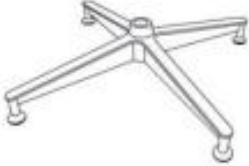

## Parts List

Label	Picture	Description	QTY
1		Ottoman cushion	1
2		Four Star Metal base	1
Label	Picture	Description	QTY
A		Ottoman cushion	1
B		Chair Base	1
C		Metal Leg	1
I		Chair Washer + Phillips head screw-Ø6*25mm	4



### step 1

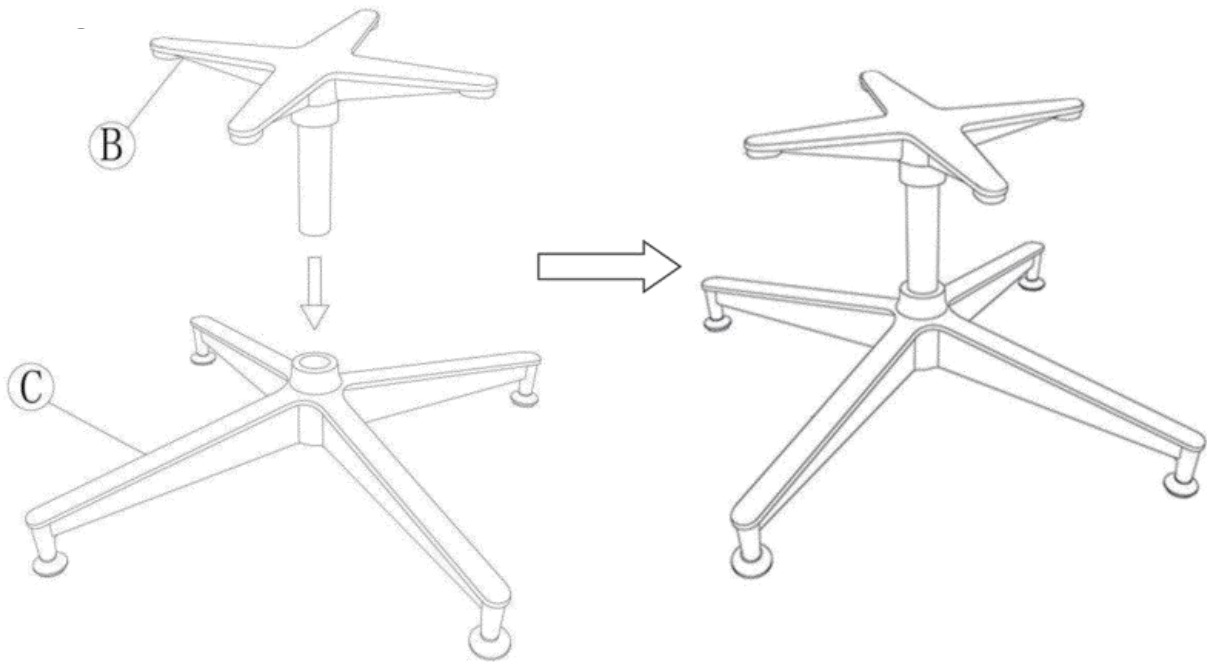

Assemble the Chair Base (B) and Metal Leg (C) as shown. That's part ①.

### step 2

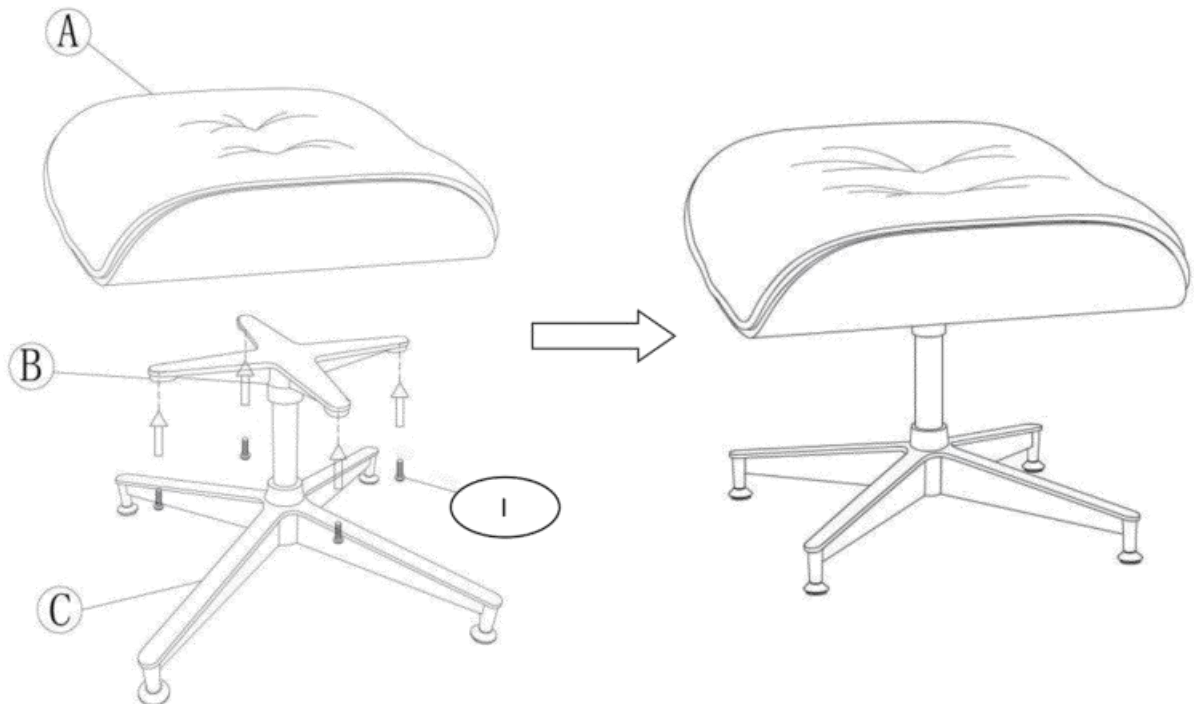

Assemble part ① and ② as shown , by using Chair Washer + Phillips head screw- $\varnothing$  6\*25mm(I).Then finished.